

Caixa de Chão - 4 Módulos

Descrição



IK08

Ref. 83002 C

Caixa para instalação em betão através das caixas de encastrar (Ref. 83052) e em piso técnico através de garras.

Disponível nas cores **CZ** - Cinzento, **AT** - Antracite e **BR** - Branco.

Aplicável com mecanismos **MEC Q45**.

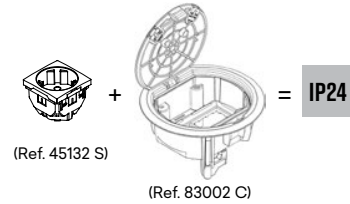

Esquema de Montagem



1 - Tampa da Caixa de Chão - 4 Módulos.

2 - Parafuso autorroscante para garra plástica.

3 - Caixa de Chão - 4 Módulos (**Ref. 83002 C**).

4 - Parafuso autorroscante para garra plástica.

5 - Caixa de Encastrar para Caixa de Chão - 4 Módulos (**Ref. 83052**).

6 - Garra plástica para Caixas de Chão.

Dimensões (mm)

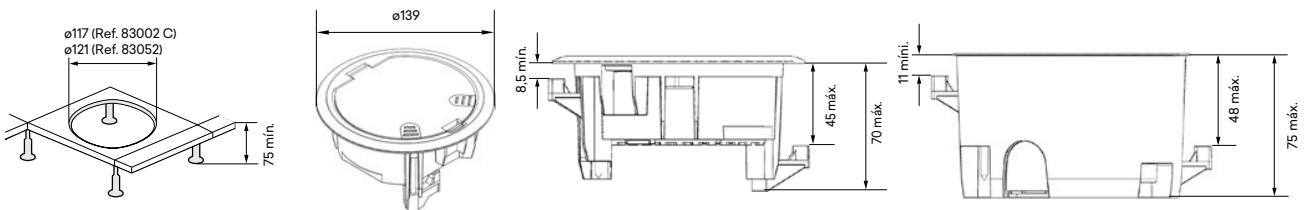

Caixas de Chão - 8, 12, 16, 24 Módulos

Descrição



IK10

Ref. 83004 C | 83006 C | 83008 C | 83012 C

Caixa para instalação em betão através das caixas de encastrar e em piso técnico através de garras.

Disponível nas cores **CZ** - Cinzento, **AT** - Antracite.

Disponível com Tampa Inox (Ref. 83008 C) nas cores **ZI** - Cinzento/Inox, **AI** - Antracite/Inox.

Aplicável com mecanismos **MEC Q45**.

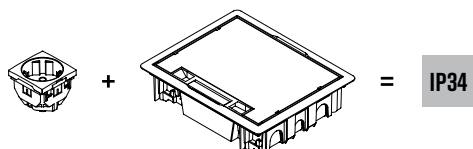

Instalação em Piso Técnico

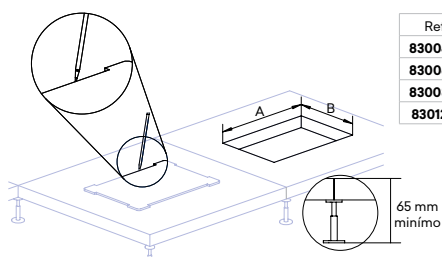

Ref.	A (mm)	B (mm)
83004 C	234	144
83006 C	234	189
83008 C	234	234
83012 C	347	234

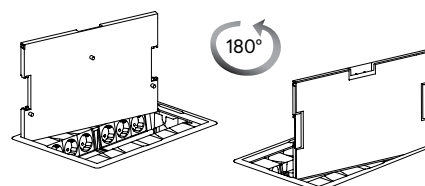
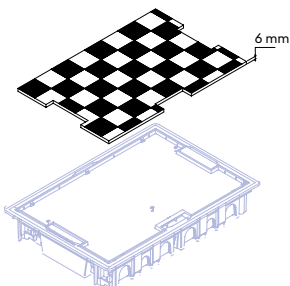
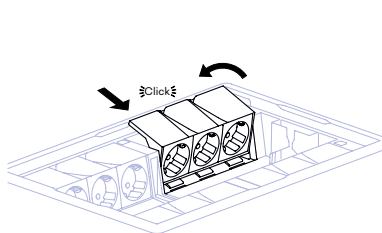
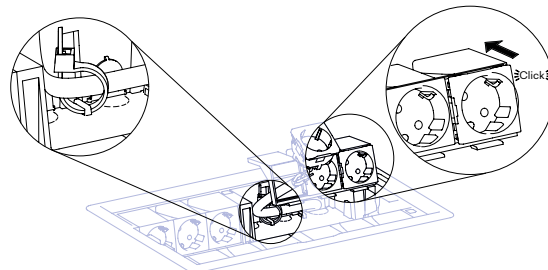
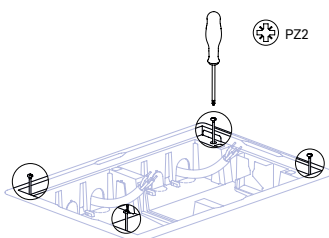
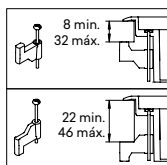
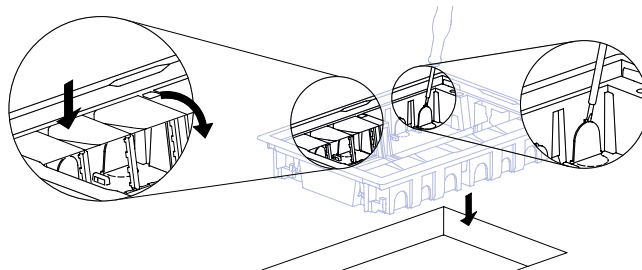

Dimensões (mm)

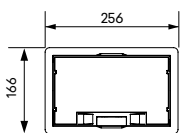

8 Módulos
Ref. 83004 C

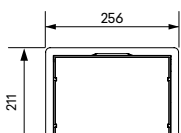

12 Módulos
Ref. 83006 C

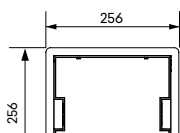

16 Módulos
Ref. 83008 C

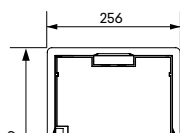

24 Módulos
Ref. 83012 C

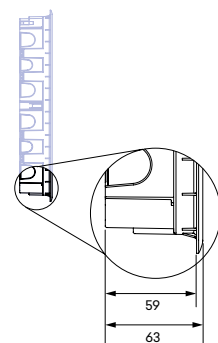

Caixas de Chão - 8, 12, 16, 24 Módulos

Instalação em Betão com Caixa de Encastrar

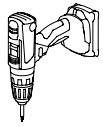

Ref	
83054	8 Módulos
83056	12 Módulos
83058	16 Módulos
83062	24 Módulos

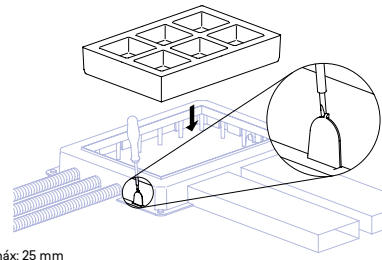
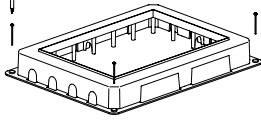

Ø máx: 25 mm
 □ máx: 120 mm x 40 mm

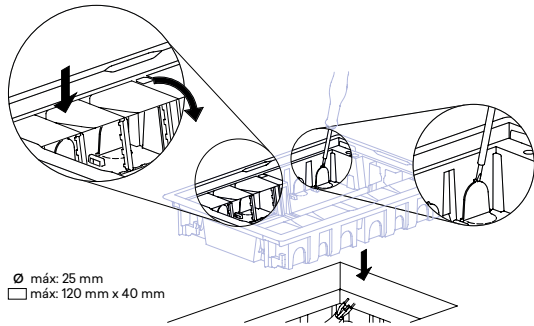
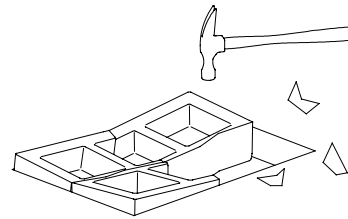
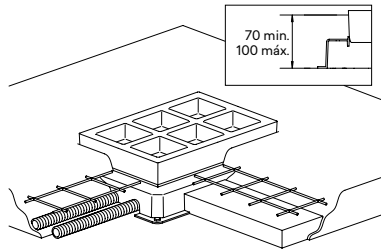

Ø máx: 25 mm
 □ máx: 120 mm x 40 mm

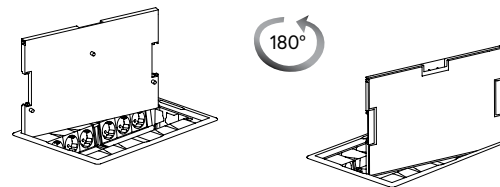
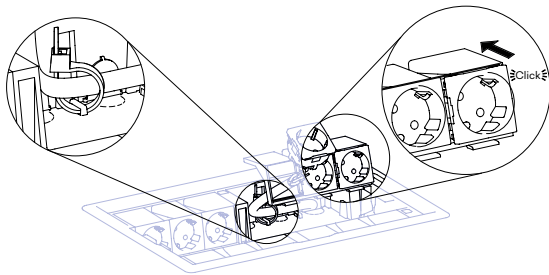
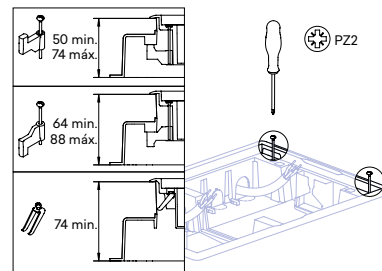

Dimensões (mm)

