



PRODUCT DATA SHEET



PART NUMBER – LC1D2510: Aftermarket direct replacement contactors for Telemecanique LC1D2510, TeSys D Series, type LC1D, 3P, 3PH, 50A, 600V, voltage max 20 hp, 1 N/O auxiliary contact, AC magnetic contactor, suitable for use with LC1-D series motor control systems.

PRODUCT SPECIFICATIONS

CONTACTORS

Voltage Selection Chart LC1D2510-XX

LC1D2510	110/120VAC
B6	24VAC
B7	24VAC
E7	48VAC
G6	110/120VAC
G7	110/120VAC
LE7	208V AC
M6	220V AC
M7	220V AC
P7	230VAC
Q6	380VAC
Q7	380VAC
R7	440VAC
T6	480VAC
U6	240VAC
U7	240VAC
V7	400VAC

Manufacturer	GLORY
Sub-Category	Contactors
Family	TeSys D
Type	LC1D
Phase	3
Poles	3
Voltage	600
Amperage	40
Coil Voltage Max	20 (HP)

REVISIONS				
ZONE	DESCRIPTION	REV.	DATE	APPROVED

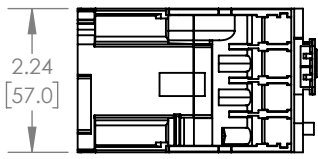
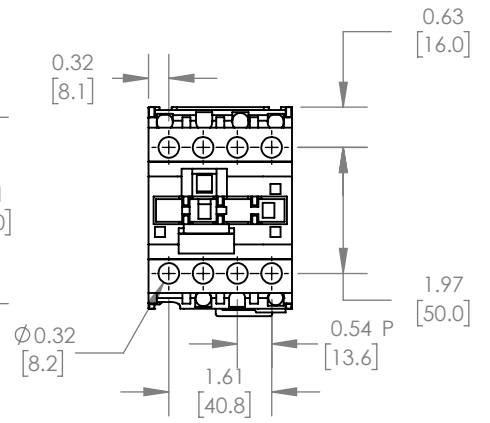
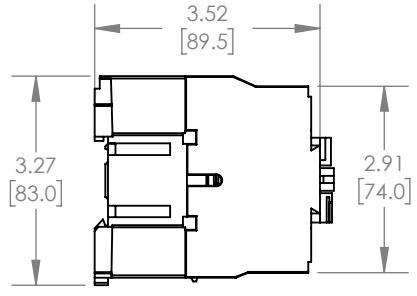
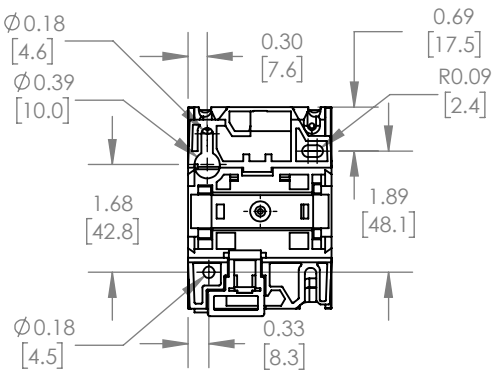
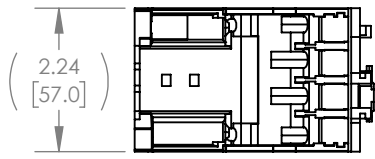
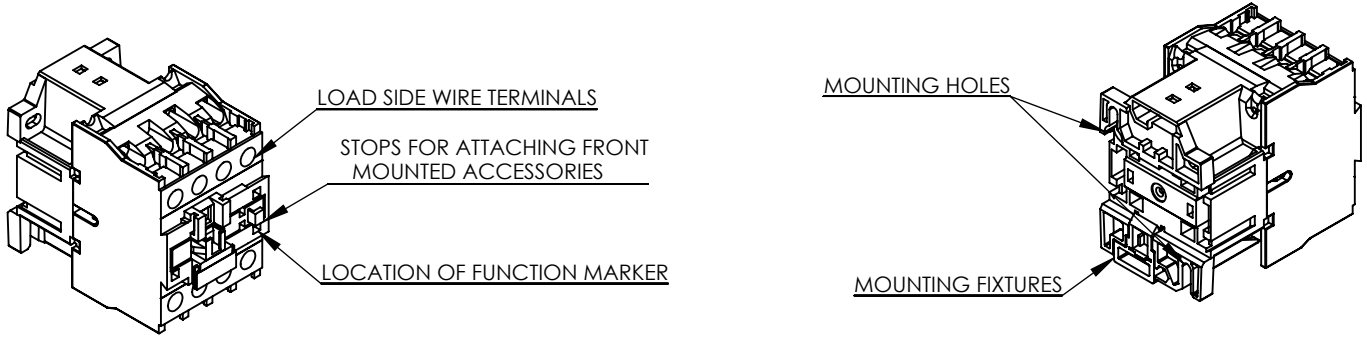

***NOTE: BRAH ELECTRIC CONTACTOR LC1D3210 IS AN AFTERMARKET DIRECT REPLACEMENT FOR LC1D2510, SERIES. SUITABLE FOR USE WITH LC1-D SERIES MOTOR CONTROL SYSTEMS.**

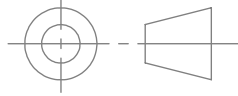
THIRD ANGLE PROJECTION

PROPRIETARY AND CONFIDENTIAL
THE INFORMATION CONTAINED IN THIS DRAWING IS THE SOLE PROPERTY OF BRAH ELECTRIC. ANY REPRODUCTION IN PART OR AS A WHOLE WITHOUT THE WRITTEN PERMISSION OF BRAH ELECTRIC IS PROHIBITED.

UNLESS OTHERWISE NOTED
ALL DIMENSIONS ARE IN INCHES
METRIC UNITS ARE DISPLAYED
BENEATH IN [MM.]

MATERIAL
MOLDED PLASTIC CASE

FINISH
N/A

DO NOT SCALE DRAWING

MAGNETIC CONTACTOR

SIZE A	DWG. NO. LC1D2510	REV. A
SCALE: 1:3	WEIGHT: 3.2 LBS	SHEET 1 OF 1